

This literature was published years prior to the establishment of Agilent Technologies as a company independent from Hewlett-Packard and describes products or services now available through Agilent. It may also refer to products/services no longer supported by Agilent. We regret any inconvenience caused by obsolete information. For the latest information on Agilent's test and measurement products go to:

www.agilent.com/find/products

Or in the U.S., call Agilent Technologies at 1-800-452-4844 (8am-8pm EST)



Agilent Technologies

8346A
26.5 to 40 GHz

8347A
100 kHz to 3 GHz

8348A
2 to 26.5 GHz

8349B
2 to 20 GHz

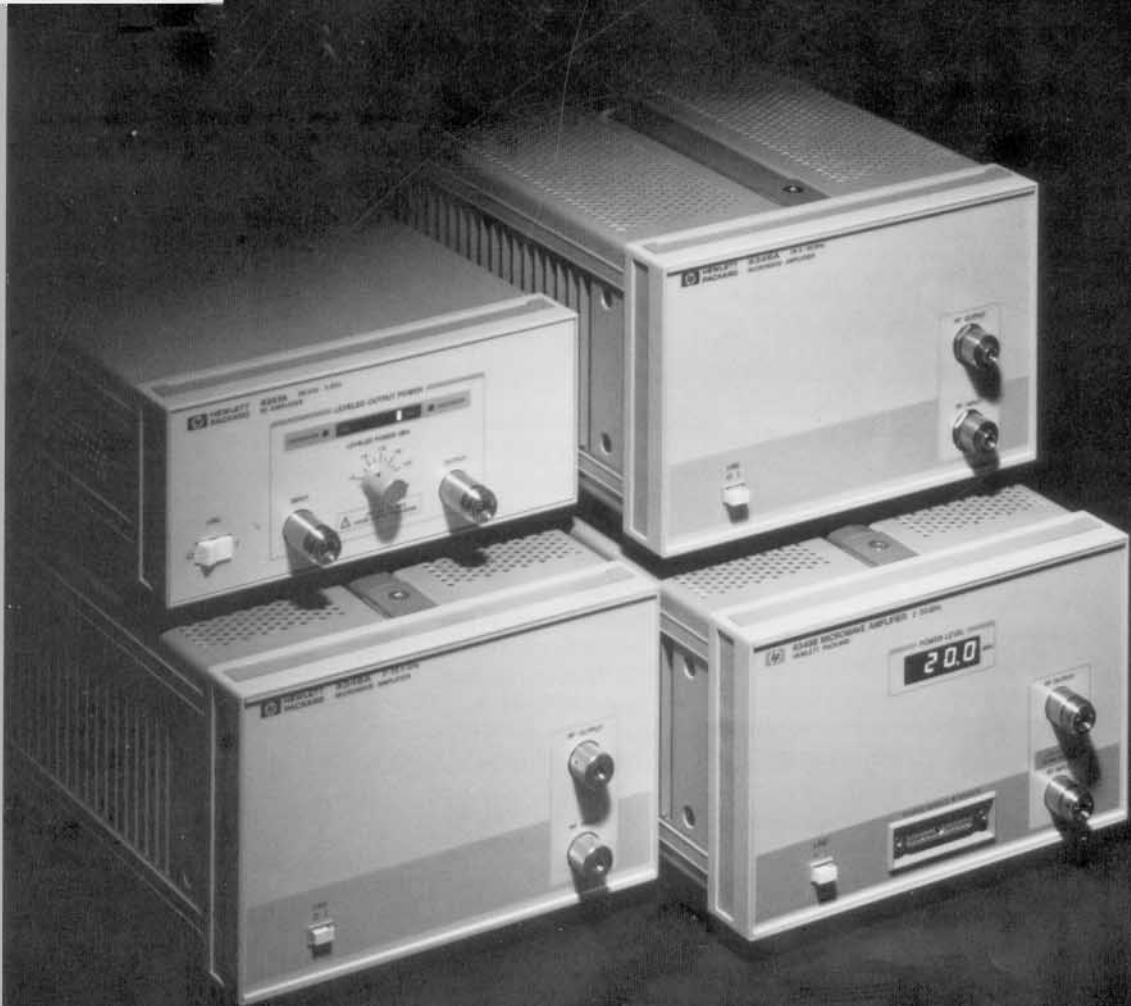

**High performance
broadband amplifiers**

General-purpose broadband amplifiers for RF through millimeter-wave...

Broadband instrumentation amplifiers

The HP 8346A, 8347A, 8348A, and 8349B are general-purpose broadband instrumentation amplifiers capable of providing gain and power to overcome systematic RF losses, drive high-power devices, improve measurement system performance, and drive millimeter-wave source modules.

Systematic power losses

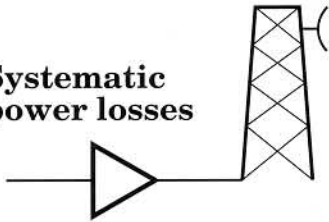

Examples of systematic power losses include switching and signal routing in ATE systems, frequency conversion, and long transmission paths to remote devices like antennas on towers. By using the HP 8346A, 8347A, 8348A, and 8349B such losses can be overcome. In antenna testing, for example, long cables often prevent enough power from reaching the antenna under test resulting in insufficient measurement dynamic range. Problems like this can be overcome by placing an amplifier at the test location, allowing the source to be operated from a more convenient location and still deliver needed power to characterize the device under test.

Driving high power devices

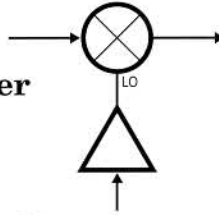

Many devices, like mixers, power amplifiers, TWT's, and optical modulators require high-power drive signals. The HP 8346A, 8347A, 8348A, and 8349B provide the power to drive and characterize these high power devices. Additionally, some of these devices are very level-sensitive. Using the internal coupler/detector of the HP 8347A and 8349B to provide flat, leveled output power allows proper device operation for complete characterization of power sensitive devices and reduces mismatch and reflection effects in a measurement system.

Amplifier selection guide

	HP 8346A	HP 8347A	HP 8348A	HP 8349B
Frequency Range	26.5–40 GHz	100 kHz–3 GHz	2–26.5 GHz	2–20 GHz
Internal Coupler/Detector	NO	YES	NO	YES
Source Module Interface	NO	NO	NO	YES
Connector Type	2.4 mm(m)	Type-N(f)	3.5 mm(m)	Type-N(f)

Improving measurement system performance

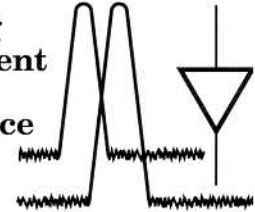

Filter rejection and switch isolation are examples of device characterizations requiring a great deal of dynamic range. The HP 8347A, 8348A, and 8349B can be used to increase low-level sweep speed in increased dynamic range measurements using a network analyzer.

Dedicated driver for the HP millimeter-wave source modules (HP 8349B only)

The HP 8349B provides the power, DC bias, and control lines needed for proper operation of the HP 83550-series of millimeter-wave source modules.

HP 8346A Amplifier specifications

Specifications describe the instrument's warranted performance over the temperature range 20 to 30°C. **Supplemental characteristics**, denoted typical or nominal, are intended to provide information useful in applying the instrument, but are non-warranted parameters.

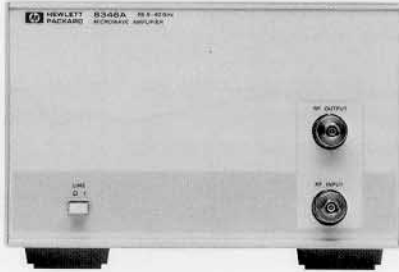

Frequency range: 26.5 to 40.0 GHz

Maximum output power:

(at +7 dBm input)

25.0 to 26.5 GHz: $\geq +17$ dBm (typical)
 26.5 to 38.0 GHz: $\geq +17$ dBm
 38.0 to 40.0 GHz: $\geq +13$ dBm

Typical maximum unlevelled output power

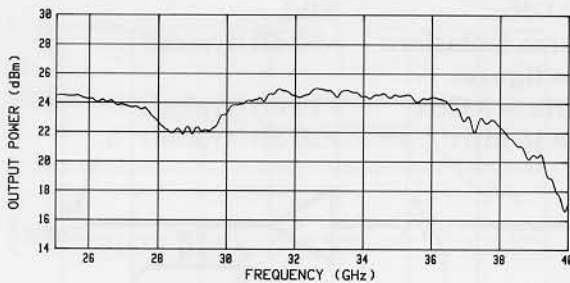

Power flatness:

(at +7 dBm input)

26.5 to 38 GHz: ± 3 dB (typical)
 26.5 to 40 GHz: ± 4 dB (typical)

Minimum small signal gain:

(at -5 dBm input)

25.0 to 26.5 GHz: ≥ 10 dB (typical)
 26.5 to 38.0 GHz: ≥ 10 dB
 38.0 to 40.0 GHz: ≥ 8 dB

Harmonics:

(at maximum specified output power)

< -30 dBc (typical)

Maximum continuous input:

Microwave Power: +22 dBm
 DC Voltage: ± 10 V

Input and output impedance:

50 Ω , nominal

Input SWR: $< 4:1$ (typical)

Output SWR: $< 3:1$ (typical)

Reverse isolation:

26.5 to 38 GHz: > 35 dB (typical)

38 to 40 GHz: > 25 dB (typical)

Noise figure:

< 13 dB (typical)

Pulse transmission capability

Rise/fall time: < 10 ns (typical)

Delay time: < 10 ns (typical)

General specifications

Input and output connectors: 2.4 mm male

Power requirement: 50 to 400 Hz, 100, 120, 200, or 240 Volts AC ($\pm 10\%$); 85 VA maximum

Weight: Net 7 kg (15 lb); shipping 14 kg (31 lb).

Dimensions: 133 H x 214 W x 366 mm D (5.2 H x 8.4 W x 14.4 in D).

HP 8347A Amplifier specifications

Specifications describe the instrument's warranted performance over the temperature range 20 to 30°C. **Supplemental characteristics**, denoted typical or nominal, are intended to provide information useful in applying the instrument, but are non-warranted parameters.



Frequency range: 100 kHz to 3 GHz

Maximum leveled output power:
 $\geq +20$ dBm

Output power leveling range:
 $+2$ to $+20$ dBm

1 dB compression point:
 $+22$ dBm nominal

Power flatness: (ALC On) ± 1.5 dB

Minimum small signal gain:
 ≥ 25 dB

Typical gain

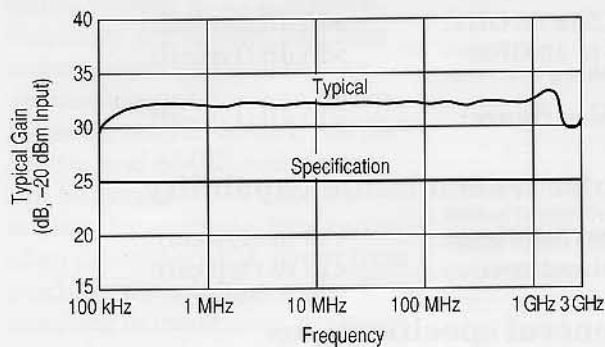

Harmonics: (at maximum specified output power)

ALC Off: < -25 dBc

ALC On: < -20 dBc

Third-order intercept: $+30$ dBm, nominal

Typical harmonics

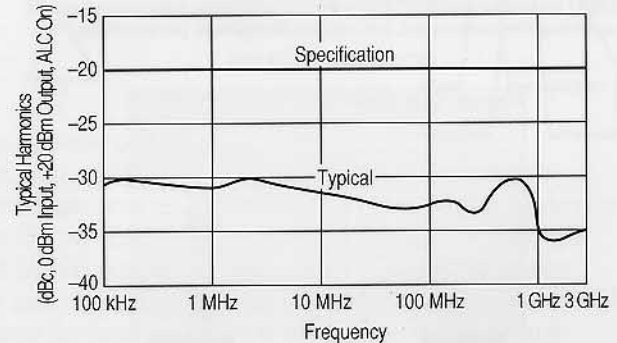

Maximum continuous input:

Microwave power: $+27$ dBm

DC voltage: ± 10 V

Input and output impedance:

50Ω , nominal

Input SWR: $< 2.0:1$ (typical)

Output SWR: (typical)

ALC on: $1.5:1$

ALC off:

Below 2 GHz: $2.0:1$

2 to 3 GHz: $3.0:1$

Reverse isolation: > 60 dB (typical)

Noise figure:

10 MHz to 3 GHz: < 15 dB (typical)

Below 10 MHz: < 20 dB (typical)

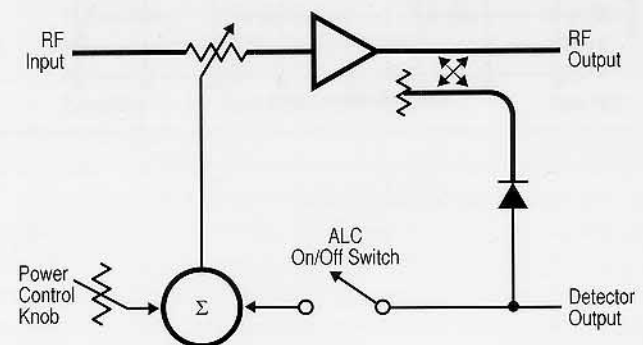

Simplified block diagram

General specifications

Input and output connectors: Type N Female

Power requirement: 50 to 400 Hz, 100, 120, 200, or 240 Volts AC ($\pm 10\%$); 45 VA maximum

Weight: Net 4 kg (8 lb); shipping 5 kg (11 lb).

Dimensions: 102 H x 213 W x 298 mm D (4 H x 8.4 W x 11.7 in D).

HP 8348A Amplifier specifications

Specifications describe the instrument's warranted performance over the temperature range 20 to 30°C. **Supplemental characteristics**, denoted typical or nominal, are intended to provide information useful in applying the instrument, but are non-warranted parameters.

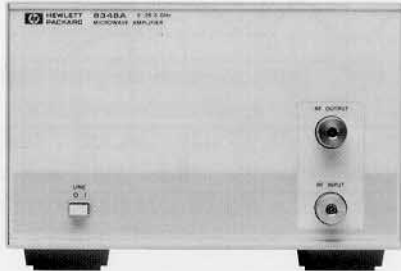

Frequency range: 2.0 to 26.5 GHz

Maximum output power:

(at 0 dBm input)

1.0 to 2.0 GHz: $\geq +20$ dBm (typical)
 2.0 to 20.0 GHz: $\geq +25$ dBm
 20.0 to 26.5 GHz: $\geq +23$ dBm

Typical maximum unlevelled output power

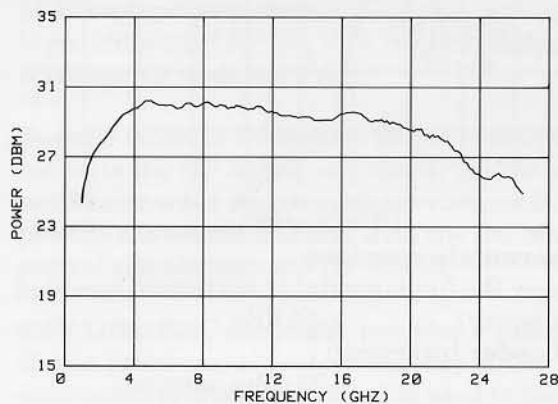

Power flatness:

(at 0 dBm input) ± 4 dB (typical)

Minimum small signal gain:

(at -15 dBm input)

1.0 to 2.0 GHz: ≥ 20 dB (typical)
 2.0 to 20.0 GHz: ≥ 25 dB
 20.0 to 26.5 GHz: ≥ 23 dB

Harmonics: (typical)

(at maximum specified output power)

1.0 to 2.0 GHz: < -20 dBc
 2.0 to 26.5 GHz: < -15 dBc

Typical second and third order harmonics

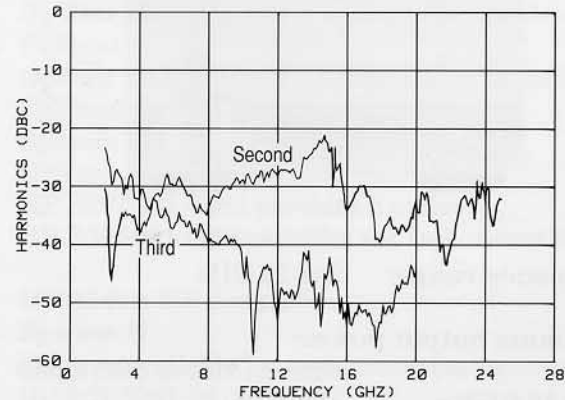

Third order intercept:

2.0 to 20.0 GHz: +36 dBm, nominal
 20.0 to 26.5 GHz: +31 dBm, nominal

Maximum continuous input:

Microwave power: +22 dBm
 DC Voltage: ± 10 V

Input and output impedance:

50Ω, nominal

Input SWR: $< 3:1$ (typical)

Output SWR: (typical)

1.0 to 2.0 GHz: $< 6:1$

2.0 to 20 GHz: $< 4.5:1$

20 to 26.5 GHz: $< 2:1$

Reverse isolation: > 50 dB (typical)

Noise figure: (typical)

1.0 to 20 GHz: < 10 dB

20 to 26.5 GHz: < 13 dB

Pulse transmission capability

Rise/fall time: < 5 ns (typical)

Delay time: < 5 ns (typical)

General specifications

Input and output connectors: 3.5 mm male

Power requirement: 50 to 400 Hz, 100, 120,

200, or 240 Volts AC ($\pm 10\%$); 85 VA maximum

Weight: Net 7 kg (15 lb); shipping 14 kg (31 lb).

Dimensions: 133 H x 214 W x 366 mm D (5.2 H x 8.4 W x 14.4 in D).

HP 8349B Amplifier specifications

Specifications describe the instrument's warranted performance over the temperature range 20 to 30°C. **Supplemental characteristics**, denoted typical or nominal, are intended to provide information useful in applying the instrument, but are non-warranted parameters.



Frequency range: 2 to 20 GHz

Maximum output power:

	Unleveled (at +5 dBm input)
2.0 to 18.6 GHz:	+20 dBm
18.6 to 20 GHz:	+18 dBm
Internally leveled	
2.0 to 18.6 GHz:	+19 dBm
18.6 to 20 GHz:	+17 dBm

Power flatness: ± 3 dB (at 0 dBm input)

1 dB compression point: +21 dBm, nominal

Typical maximum unleveled output power

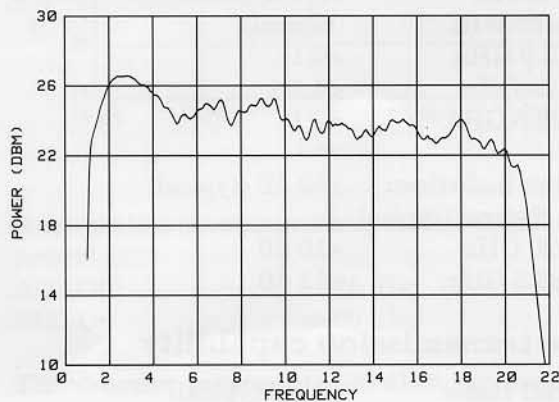

Power flatness: (ALC On) ± 1.25 dB

LED display accuracy

Calibrated range:	+0 dBm to +20 dBm
Calibrated accuracy:	± 1.5 dB

Minimum small signal gain:

(at -5 dBm input)

2.0 to 18.6 GHz:	≥ 15 dB
18.6 to 20.0 GHz:	≥ 13 dB

Typical small signal gain (at -5 dBm input)

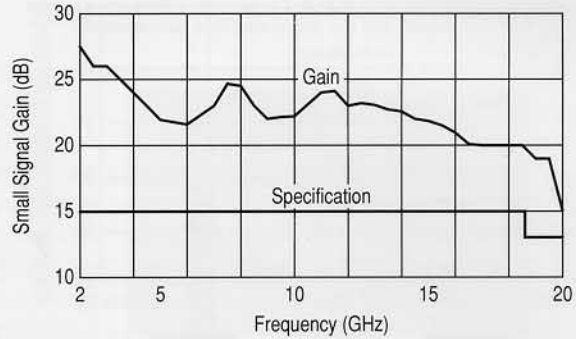

Harmonics: (at maximum specified output power)

2.0 to 11.0 GHz:	< -20 dBc
11.0 to 20.0 GHz:	< -30 dBc

Typical second and third order harmonics

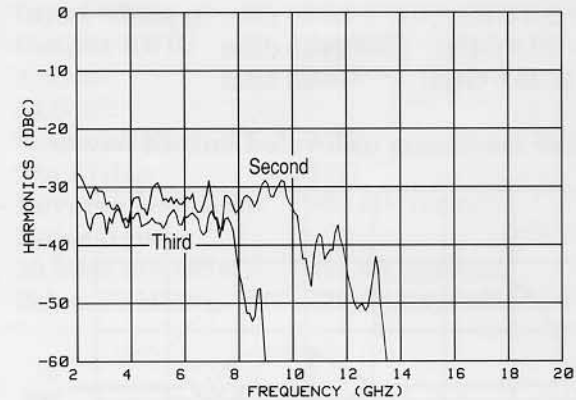

Non-harmonic spurious

(dB below the fundamental at maximum specified output power): < -55 dBc

Third order intercept:

+33 dBm, nominal

Maximum continuous input:

Microwave power:	+27 dBm
DC voltage:	± 10 V

Input and output impedance:

50 Ω , nominal

Input SWR: $\leq 2.8:1$ (typical)

Output SWR: (typical)

ALC on: $\leq 2.5:1$

ALC off:

2.0 to 5.0 GHz: $\leq 4.8:1$

5.0 to 11.0 GHz: $\leq 3.8:1$

11.0 to 20.0 GHz: $\leq 3.2:1$

Reverse isolation: > 50 dB (typical)

Noise figure: < 13 dB (typical)

Pulse transmission capability

Rise/fall time: <10 ns (typical)
Delay time: <8 ns (typical)

General specifications

Input and output connectors: Type N Female
Power requirement: 50 to 400 Hz, 100, 120, 200, or 240 Volts AC ($\pm 10\%$); 85 VA maximum
Weight: Net 7 kg (15 lb); shipping 14 kg (31 lb).
Dimensions: 133 H x 214 W x 366 mm D (5.2 H x 8.4 W x 14.4 in D).

Rear panel inputs

POS Z BLANK: BNC connector, holds the amplifier's LED power display, and the external display while the swept source passes switch points and retraces.

Rear panel outputs

Detector output: BNC connector, outputs approximately -10mV/mW for use when leveling.

Millimeter-wave source modules (option 002 is recommended for use with the HP millimeter-wave source modules)

Source module interface: 20-pin B connector, connects the HP 8349B and the HP 83550 series millimeter-wave source modules via a cable to provide the source modules with the DC bias and control signals from the HP 8349B.

0.5V/GHz: BNC connector, provides a voltage that is proportional to the frequency of the microwave source. This signal is used in the power flatness correction feature.

Synthesizer interface: 20-pin B connector, connects the HP 8349B to a compatible source to enable the source to pass information directly to and from the millimeter-wave source modules.

Ordering information

HP 8346A and 8348A Amplifiers

Option 001: Rear panel RF input/output

Option 002: Rear panel RF input and front panel RF output

Option 910: Extra operating manual

Option 1BN: MIL-STD 45662A Certificate of Calibration

Option 1BP: MIL-STD 45662A Certificate of Calibration with Data

System II

Kits are available for rack mounting.

HP P/N 5061-0089 provides handles.

HP P/N 5061-0057 provides the rack mount flange.

HP 8347A RF Amplifier

System II

Kits are available for rack mounting as

HP P/N 5061-9672

HP 8349B Amplifier

Option 001: Rear panel RF input/output

Option 002: Rear panel RF input and front panel RF output

Option 910: Extra operating manual

System II

Kits are available for rack mounting.

HP P/N 5061-0089 provides handles.

HP P/N 5061-0057 provides the rack mount flange.

Agilent Technologies' Test and Measurement Support, Services, and Assistance

Agilent Technologies aims to maximize the value you receive, while minimizing your risk and problems. We strive to ensure that you get the test and measurement capabilities you paid for and obtain the support you need. Our extensive support resources and services can help you choose the right Agilent products for your applications and apply them successfully. Every instrument and system we sell has a global warranty. Support is available for at least five years beyond the production life of the product. Two concepts underlie Agilent's overall support policy: "Our Promise" and "Your Advantage."

Our Promise

Our Promise means your Agilent test and measurement equipment will meet its advertised performance and functionality. When you are choosing new equipment, we will help you with product information, including realistic performance specifications and practical recommendations from experienced test engineers. When you use Agilent equipment, we can verify that it works properly, help with product operation, and provide basic measurement assistance for the use of specified capabilities, at no extra cost upon request. Many self-help tools are available.

Your Advantage

Your Advantage means that Agilent offers a wide range of additional expert test and measurement services, which you can purchase according to your unique technical and business needs. Solve problems efficiently and gain a competitive edge by contracting with us for calibration, extra-cost upgrades, out-of-warranty repairs, and on-site education and training, as well as design, system integration, project management, and other professional engineering services. Experienced Agilent engineers and technicians worldwide can help you maximize your productivity, optimize the return on investment of your Agilent instruments and systems, and obtain dependable measurement accuracy for the life of those products.

By internet, phone, or fax, get assistance with all your test & measurement needs

Online assistance:

www.agilent.com/find/assist

Phone or Fax

United States:
(tel) 1 800 452 4844

Canada:
(tel) 1 877 894 4414
(fax) (905) 282 6495

China:
(tel) 800 810 0189
(fax) 1 0800 650 0121

Europe:
(tel) (31 20) 547 2323
(fax) (31 20) 547 2390

Japan:
(tel) (81) 426 56 7832
(fax) (81) 426 56 7840

Korea:
(tel) (82 2) 2004 5004
(fax) (82 2) 2004 5115

Latin America:
(tel) (305) 269 7500
(fax) (305) 269 7599

Taiwan:
(tel) 080 004 7866
(fax) (886 2) 2545 6723

Other Asia Pacific Countries:
(tel) (65) 375 8100
(fax) (65) 836 0252
Email: tm_asia@agilent.com

Product specifications and descriptions in this document subject to change without notice.

© Agilent Technologies, Inc. 2001
Printed in USA, December 1, 1990
5091-0370E